



MOB ARMOR

2023 PRODUCT CATALOG

GET
EQUIPPED



- 4** **Phone & Small Device**
- 6 MobNetic Series
- 10 Mob Mount Series
- 12 Flex Wireless Charging
- 15 Phone Accessories
- 16 Action Camera
- 18** **Tablet**
- 20 TabNetic
- 22 Tab Mount
- 24 75mm VESA
- 25 Quick Release Series
- 26 Tablet Enclosures
- 27** **Other Products**
- 27 Flash Grips
- 28 GPS Accessories
- 28 Lifestyle Gear
- 29** **Mob Armor GPS App**

PHONE & SMALL DEVICE



SECURE MOUNTING FOR HANDHELD DEVICES AND TOOLS

Mob Armor has developed a line of smartphone mounting products over the years to be the toughest and most versatile mounts out there. From magnetic dashboard mounts like the MobNetic Maxx, to solid cradle mounts like the Mob Mount, to wireless charging mounts like the FLEX Series, we have something made for any road, any environment. With multiple mounting bases and adhesives, our mounts are made to mount practically anywhere in your vehicle, house, office, workshop, and more. Mob Armor designs and assembles all of our mounts right in America, while coming with a rock-solid 3 year warranty.

Mounting Base for Any Location



MAGNETIC MOUNTING

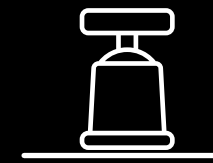

DIRECT MOUNTING

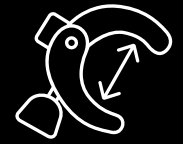

CLAW MOUNTING

Secure Options for Any Device



MobNetic Series

Our answer for the everyday, everywhere mount. These magnetic phone mounts lock your device in place with 90lb pull-force magnets for effortless on-and-off mounting. Perfect for smartphones, tools, and other small devices.



Mob Mount Series

The simple single-slide cradle phone mount for any vehicle - locking your device on your in place for the toughest of roads and the most rugged terrain. Comes in large and small sizes to accommodate nearly any size device.



FLEX Wireless Charging Series

Both Apple MagSafe and Android Qi Wireless Charging compatible, the FLEX Series provides a magnetic wireless charging and mounting solution stronger than any other. Plus, it's compatible with all of our MobNetic phone mounts when on the go.

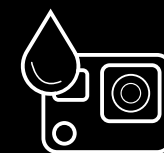

Action Camera Mounts

Our best phone mounts, made compatible with popular action camera mounting hardware. Capture the most extreme moments from nearly impossible angles with the Magnetic, Claw, or Direct mounting options, sold individually or as a bundle.

MOBNETIC SERIES

THE EVERYDAY, EVERYWHERE MOUNT.

Designed with rare-earth 90lb pull-force magnets, our MobNetic phone mounts are designed for everyday use with easy on-and-off mounting. With options for permanent, claw, and on-the-go mounting solutions, there's a MobNetic mount for everyone.

THE MAGIC OF MOBNETIC

The MobNetic mounting system works in the simplest way possible - magnets. The 90lb pull-force magnets hold your device in place for easy everyday use, while mounts with a magnetic base are held solidly in place for even the toughest of roads.

The magnets work with any ferrous surface - workbench, metal dashboard, even your fridge. When you need to mount it elsewhere, simply adhere the included Mounting Discs wherever you need them, providing a perfectly sized ferrous surface on your dashboard, desk and more.

With all of the possible combinations of magnet, claw, cradle, mounting discs, charger, and more, the MobNetic series mounts are truly **everyday, everywhere** mounts.

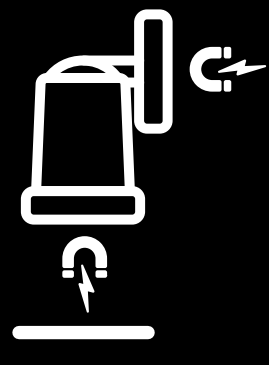

MOBNETIC MAXX



ALL-ALUMINUM BODY



90LB PULL-FORCE MAGNETS

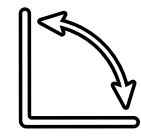

90° TILT

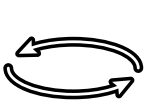

360° ROTATION

- Built with 6061-T6 aircraft grade aluminum, the most durable mounting solution we've ever produced
- Dual 90lbs pull-force magnets, capable of mounting directly to any ferrous surface & more with included Mounting Discs
- 90 degree tilt and 360 degree swivel
- Includes 2 Small Mounting Discs and 2 MobNetic Plates
- Now comes in 10 anodized aluminum colors!



SCAN TO LEARN MORE



BLACK MOB-N-MX-BLK GUNMETAL MOB-N-MX-GM SILVER MOB-N-MX-SLVR BRONZE MOB-N-MX-BRNZ GOLD MOB-N-MX-GLD BLUE MOB-N-MX-BLU PINK MOB-N-MX-PNK RED MOB-N-MX-RD BLACK CHROME MOB-N-MX-BCHR CHROME MOB-N-MX-CHR



MOBNETIC CLAW

SKU: MOBN-CLAW



90LB PULL-FORCE
MAGNET

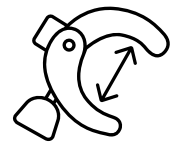

ADJUSTABLE
CLAW .25" - 2"

- Claw mount capable of gripping round or irregular tubing, roll cages, or handle bars from near 0" up to 2"
- Includes 2 MobNetic Plates
- Capable of 70° of tilt, 360° of rotation, and adjustable tension



SCAN TO
LEARN MORE



MOBNETIC GO

SKU: MOBN-GO



ALL-ALUMINUM
BODY



90LB PULL-FORCE
MAGNETS

- Double sided 90lb pull-force magnet that provides a mounting solution to any ferrous surface
- Features a smooth billet aluminum spindle contoured for any set of hands
- Safe to use with any smart device
- Includes 1 Mob Disc and 1 MobNetic Plate



SCAN TO
LEARN MORE



COMPACT. RUGGED. UNIVERSAL.

THE ESSENTIAL EVERYDAY, EVERYWHERE PHONE MOUNTS

MOBNETIC STIXX

SKU: MOBN-STX-BLK



90LB PULL-FORCE
MAGNET



ALL-ALUMINUM
BODY

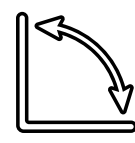

90° TILT

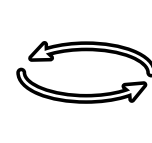

360° ROTATION

- Mount adheres directly to any flat surface where you need to mount a handheld device.
- Securely sticks in one location using a powerful non-marking 3M VHB adhesive
- Great for fleets, or you when you want it to just stick and stay
- Includes 2 MobNetic Plates



Small Mounting Discs

SKU: MOB-MD

SKU: MOB-MD



- Attach any of our magnetic mounts to non-ferrous surfaces
- 1.5" steel discs adhere 3M VHB to any flat surface
- Packs come with two mounting discs and alcohol surface cleaning wipes.

MobNetic Plates

SKU: MOBN-PL-ACC

SKU: MOBN-PL-ACC



- .02" thick and 2" tall steel plates adhere nearly flat to any device
- Package includes 2 MobNetic plates
- Note - not compatible with wireless charging products



MOB MOUNT SERIES

DESIGNED WITH AN OBSESSION FOR DURABILITY

The Mob Mount was created to perform in unforgiving terrains. It is the most capable phone mount on earth. Manufactured with aircraft grade metal and industrial materials, this is the mount built for your next adventure.



MOB MOUNT CLAW

SKU: MOBC-BLK-LG / SM

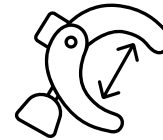

ADJUSTABLE CLAW .25" - 2"

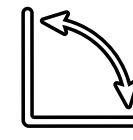

70° TILT

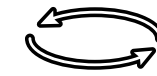

360° ROTATION

- Adjustable claw attaches mount to any round or irregular tubing, handlebars, roll cages, etc.
- Claw can grip anything from near 0" up to 2"
- Adjustable tension mount has 70° of tilt, 360° of rotation



SCAN TO LEARN MORE

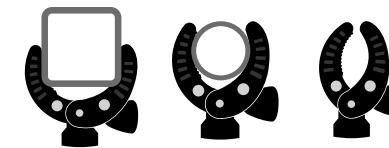

FIND THE RIGHT FIT FOR YOUR DEVICE

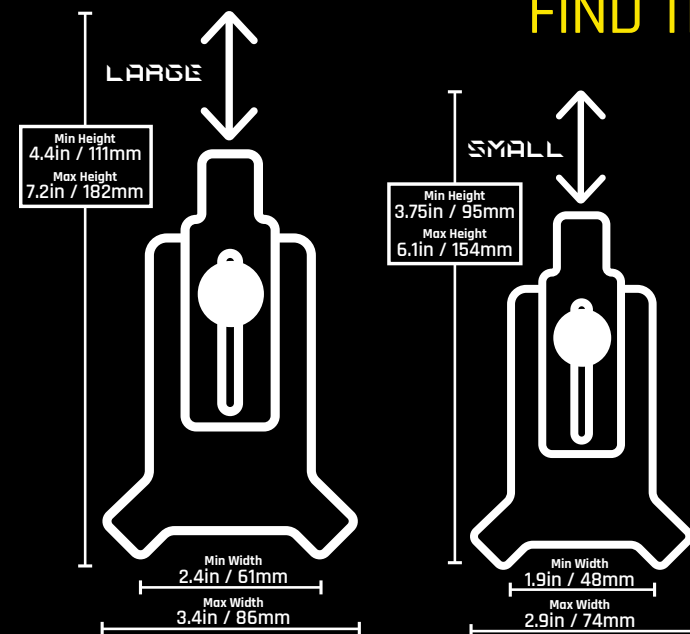

The single-slide Mob Mount system locks in phones and smaller devices with a single knob, allowing you to pop your device in and out of the mount with one hand while also locking it in for the roughest and toughest of trips.

The small Mob Mount is capable of holding smaller sized phones, like the iPhone 7 and 8, or any of the iPhone Mini's 12 and up. You can also fit many smaller Android devices - check the device measurements before buying.

The large Mob Mount is designed for the new larger phones, like the iPhone 13, 14, Max and more. It also comfortably holds Samsung Galaxy, HTC, Google Pixel phones and more.

MOB MOUNT MAGNETIC

SKU: MOBM-BLK-LG / SM



90LB PULL-FORCE MAGNET



ALL-ALUMINUM BODY

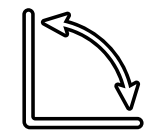

90° TILT



360° ROTATION

- Tighten down your device and attach mount to any ferrous surface
- Expand mounting locations with included Mounting Discs that will adhere to any flat surface with a powerful non-marking adhesive



SCAN TO LEARN MORE





WIRELESS CHARGING SERIES

FLEXIBLE MOUNTING. FASTER CHARGING.

The Mob Armor FLEX Series is a revolutionary magnetic wireless charging and mounting solution that gives you fast 15W wireless charging with an easy-to-use, secure mounting system that is compatible with both iPhone and Android phones. With the FLEX Series, you can charge your phone quickly, securely and with ease.

ALL ABOUT THE FLEX SYSTEM

Mob Armors FLEX mounting system builds upon existing magnetic wireless charging technology, creating an even stronger magnetic wireless charging bond for the toughest of environments while retaining fast 15W wireless charging. When paired with one of our MobNetic magnetic phone mounts or countless other mounts available, the mounting and charging options are practically endless.

The FLEX system consists of a few parts working in unison. First, attached to your phone is the Mag FLEX Plate - a thin, round disc the same size as a Qi wireless charging array with a magnet array built in. This creates a stronger-than-MagSafe bond with the FLEX Magnetic Wireless Charger, which is connected USB-C to USB-C to our 38W Dual USB Car Charger, or a wall outlet.

On the rear of the FLEX Magnetic Wireless Charger, you can attach one of our MobNetic phone mounts to prop up the charger in nearly any angle you desire - creating the most versatile mounting and charging solution on the market.

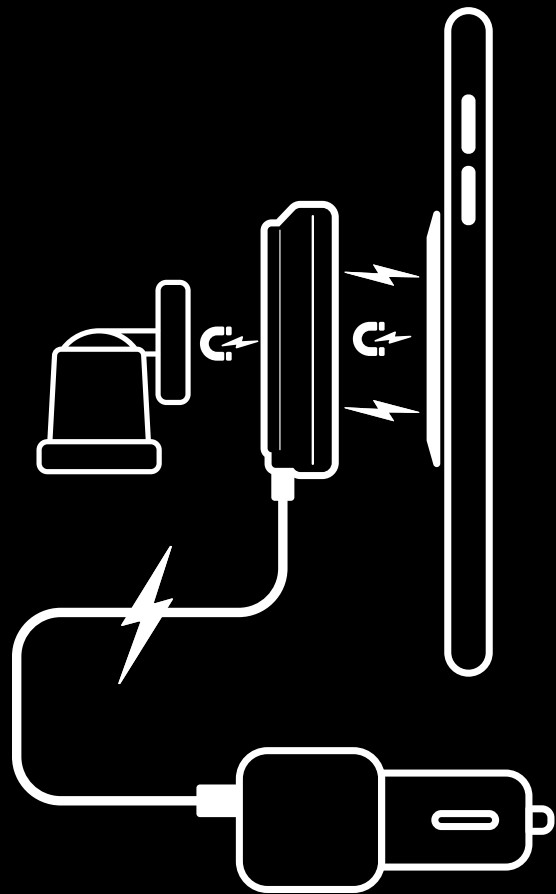

SKU: MAG-FLEX-WC

- Rugged 15W wireless charging system, built for everything from your daily commute to a long offroad excursion
- Designed specifically to work with your existing MobNetic phone mount, upgrading to an easy on-and-off charging and mounting solution
- Compatible with both Android and Apple devices. Works seamlessly with MagSafe wireless charging, and even adds magnetic wireless charging capability to Qi Wireless Charging Android devices
- USB-C charging cable, Mag FLEX Plate, and alignment template also included



SCAN TO
LEARN MORE



SKU: MAG-FLEX-WC-KIT



- The ultimate dashboard phone mounting system, with the strongest wireless charger meeting the toughest phone mount, all in one package
- MobNetic Maxx with FLEX Magnetic Wireless Charger on top allows for practically unlimited mounting and charging combinations
- Included in the box: MobNetic Maxx, FLEX Magnetic Wireless Charger, 38W Dual USB Car Charger, Mag FLEX Plate, 2 Mounting Discs, and USB-C charging cable

MAG FLEX PLATE

SKU: MAG-FLEX



- Low-profile adhesive magnetic plate designed specifically to work with MagSafe and Qi Wireless charging devices
- Creates additional magnetic bond between the FLEX Magnetic Wireless charger and your device, stronger than MagSafe.
- Doubles as a slim, light-duty magnetic phone mount



FLX RETROCAP

SKU: MAG-FLEX-RETRO

- Our simple solution for using a device with the Mag FLEX Plate attached without wireless charging
- Metal disc increases the ferrous surface area between the Mag FLEX Plate magnets, creating a strong bond between it and our MobNetic phone mounts



38W Dual USB Car Charger

SKU: ACC-USB-QCPD

- High-speed aluminum-body dual USB car charger, designed with Mob Armor toughness. Features one PD 20W USB-C plug, and one QC 3.0 USB-A plug
- Combined charging output of 38W, with smart device protection against short circuits, overheating, variable voltage, and more.



OTHER SMALL DEVICE MOUNTING

RAD MOUNT

SKU: MOB-RAD-HH



- Mount your handheld radio to any ferrous surface with the 90lb pull-force magnet, or hard mount it
- 5052 aluminum alloy construction provides a durable but lightweight mount, always keeping your radio within reach
- Includes 2 rubber pads for shock absorption and 2 Mob Discs for alternative mounting solutions



Mob Mount Maxx Accessory

SKU: MOB2-MX-ACC



Mini Gecko

SKU: G-MINI-BK



Powder-coated metal suction cup plate that allows you to attach your Mob Mount Magnetic, MobNetic, Flash Grip, or Action Cam Mount to any smooth, non-porous surface.



Charging Cables

SKU: MOB-CBL-MICROB
MOB-CBL-USBC
MOB-CBL-LGHTNG

Ultra-flexible Quick Charge 3.0 compatible cables allow for rapid charging and syncing. Available in USB-A to Lightning, USB-C or Micro USB. Compatibility: 5V/3A 9V/2A 12V/1.5A

MobNetic Direct

SKU: MOBN-MX-MK



We put our aluminum MobNetic housing on a permanent mounting base, for those who don't need to move their mounts around. Features a 90lb pull-force magnet, 90 degrees tilt, and an aluminum base with two mounting holes.

MobNetic Flush

SKU: MOBN-MX-FL



For when you need a slim mount that doesn't move - 90lb pull-force magnet affixed to an aluminum base, with two mounting holes for permanent mounting.



ACTION CAMERA SERIES

GET THE IMPOSSIBLE SHOTS

Mob Armor Action Camera mounts are the perfect choice for extreme sports enthusiasts and adventurers who want to capture the thrill of their outdoor expeditions. Our mounts provide a secure, reliable connection between any standard action camera and vehicles, handlebars, dashboards, or other objects. With Mob Armor Action Camera Mounts, you'll never miss a shot!

BUY INDIVIDUAL MOUNTS, OR AS A BUNDLE

Mob Armor Action Camera mounts are designed to be versatile and have been tested under rigorous conditions. Each mount is made of rugged thermoplastics so they won't weigh you down while recording your adventure. The mounts come with all the necessary accessories, making it easy to set up in almost any situation. When bought as a bundle, you'll save a few dollars in the mounts themselves, as well as get an organized carrying case with space for a camera and additional mounting accessories.

ACTION CAM BUNDLE

SKU: AC-BNDL

Our Action Cam Bundle comes with everything you need to get the perfect shot. All your accessories in a compact Mob Armor branded travel case with room for your own action camera. Pack includes:

- Action Cam Magnetic Mount
- Action Cam Direct Magnetic Mount
- Action Cam Claw Mount
- 2 extra pivoting extension
- 3 Mounting Discs
- 4 thumb screws
- Nylon shell case



Action Cam Magnetic

SKU: AC-MAG



90LB PULL-FORCE
MAGNET



ALL-ALUMINUM
BODY

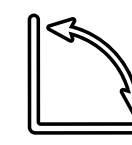

90° TILT



360° ROTATION

Action Cam Direct

SKU: AC-DMAG



90LB PULL-FORCE
MAGNET



Action Cam Claw

SKU: AC-CLAW

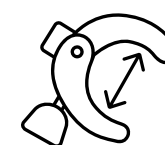

ADJUSTABLE
CLAW .25" - 2"

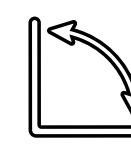

70° TILT



360° ROTATION



TABLET



LOCK DOWN ANY DEVICE

Mob Armor tablet mounting products are renowned for their versatility and reliability. Boasting multiple mounting options, you can use them in a variety of settings. Not only that, but they provide superior strength and durability - essential when you need your device to stay put. For peace of mind, every Mob Armor tablet product comes with a three year warranty.

Whether you're in the off-road trucking industry, working on the sea, involved in industrial work or construction, or managing a storefront, you can trust Mob Armor to securely mount your tablet. With our products, you have the confidence that your device will be held firmly and securely no matter what environment it's in.

Mounting Base for Any Location



MAGNETIC MOUNTING

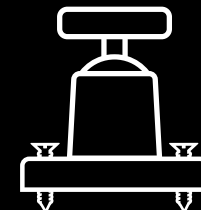

DIRECT MOUNTING

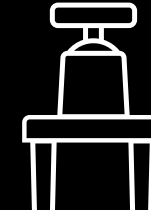

TUBE MOUNTING



FLUSH MOUNTING

Secure Options for Any Device



TabNetic Series

To put it simple, one of the easiest tablet mounts you'll ever use. With a 290lb pull-force magnet on top, you can easily pop your tablet on and off for everyday light and medium duty use, both in and out of your vehicle.

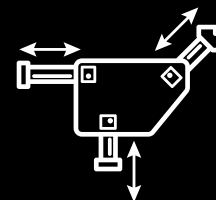

Tab Mount Series

The three-slide cradle holds any tablet sized 7-13", locking it in for even the toughest of tests. The Tab Mount is the ultimate heavy duty tablet mount, capable of practically anything you throw at it.



75mm VESA & Quick Release Series

Designed specifically for use with our T-Series tablet enclosures, these are our mounting solutions for extreme conditions. The standard 75mm VESA pattern is also compatible with many other VESA devices, such as monitors and equipment.

TABNETIC SERIES



THE MOST VERSATILE MOUNT FOR LARGE DEVICES

The TabNetic series allows for a quick-release docking location for devices such as tablets, small monitors, and tools with 290lb pull-force magnets. TabNetic mounts also work seamlessly with all of our tablet enclosures.

All TabNetic products come with two steel shield plates that can adhere to any device using a powerful and non-marking 3M VHB.

TABNETIC

SKU: TABN-MX-TUBE **MAXX** TUBE

- Adjustable double clamp base locks the mount on to any tube or bar 1.5-2" in diameter
- 290lb pull-force magnet and all-aluminum housing allows for use in rough environments
- Two notches on either side of the ball housing offers 180 degrees of device tilt, and 360 degrees rotation.
- Package includes 2 TabNetic Plates for your devices



290LB PULL-FORCE MAGNET

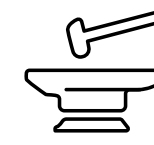

ALL-ALUMINUM DUAL NOTCH BODY

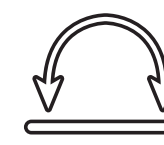

180° TILT

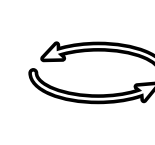

360° ROTATION



TABNETIC **MAXX**

SKU: TABN-MX-BLK

- Dual-sided magnet mount capable of unlimited mounting options, twice as large as the MobNetic Maxx
- The strength of the magnets and all-aluminum housing allows for use around heavy-duty equipment
- Two notches on either side of the ball housing offers 180 degrees of device tilt, and 360 degrees rotation.
- Expanded mounting options with included 2 TabNetic Plates and 2 Large Mounting Discs



290LB PULL-FORCE MAGNETS



ALL-ALUMINUM DUAL NOTCH BODY

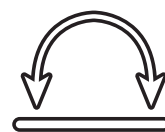

180° TILT

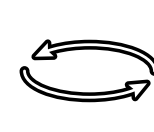

360° ROTATION



SCAN TO LEARN MORE



TABNETIC

SKU: TABN-MX-FL **MAXX** FLUSH



- Designed with "slim" in mind, allowing you to mount tablets flush with nearly any flat surface.
- 4.25" x 2.5" solid metal base with screw holes allows you affix the mount to nearly any flat surface. All necessary hardware included
- 290lb pull-force quick-release magnet mount with the ability to fix to most flat surfaces

TABNETIC

SKU: TABN-MX-MK **MAXX** DIRECT



- 290lb pull-force magnet and all-aluminum housing allows for use in rough environments
- Two notches on either side of the ball housing offers 180 degrees of device tilt, and 360 degrees rotation
- 4.25" x 2.5" solid metal base with screw holes allows you affix the mount to nearly any flat surface. All necessary hardware included

TAB MOUNT SERIES

UNIVERSAL TABLET MOUNTING

The Tab Mount was created to perform in the most unforgiving terrains. Manufactured with aircraft grade aluminum and industrial materials, this is the mount can handle practically any adventure you throw at it.

UNIVERSAL, UNIQUE TRIPLE SLIDE DESIGN

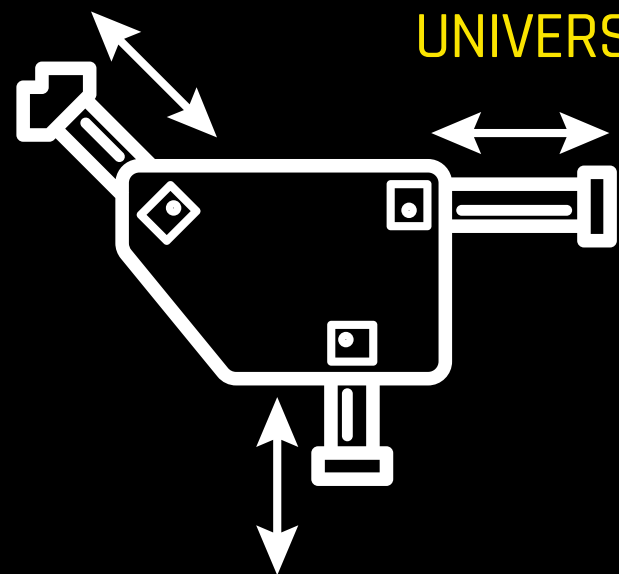

With a lightweight yet durable powder-coated aluminum alloy cradle, the Tab Mount system is designed to hold most tablets sized 7" to 13", and up to 1" thick with or without a case.

The unique triple slide design locks in tablets of practically any aspect ratio, with a simple twist-to-tighten design. Also included with every Tab Mount are adhesive closed-cell EVA foam pads, meant to close the gap between your tablet and the mount and protect it from vibration on rough trails.

With different mounting bases for different vehicles and purposes, the Tab Mount is the most capable tablet mounting solution on the planet.

TAB MOUNT MAXX MAGNETIC

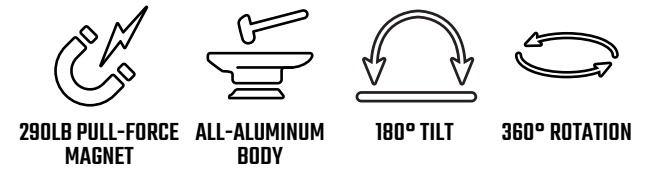

SKU: **TAB-Y-MX-MAG**

- 290lb pull-force magnet and all-aluminum housing allows for use around heavy-duty equipment
- Two notches on either side of the ball housing offers 180 degrees of device tilt, and 360 degrees rotation.
- Expanded mounting options with included 2 Large Mounting Discs

TAB MOUNT MAXX TUBE

SKU: **TAB-Y-MX-TUBE**

- Adjustable double clamp base locks the mount on to any tube or bar 1.5-2" in diameter
- Two notches on either side of the ball housing offers 180 degrees of device tilt, and 360 degrees rotation.

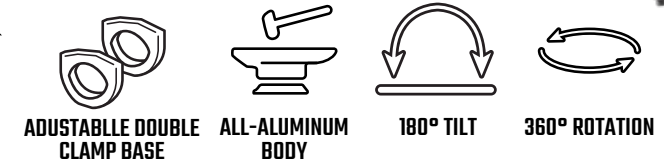

TAB MOUNT MAXX DIRECT



SKU: **TAB-Y-MX-MK**

- Solid metal double-screw base allows for a secure universal mount to be fixed to any flat surface with included hardware.
- Two notches on either side of the ball housing offers 180 degrees of device tilt, and 360 degrees rotation.

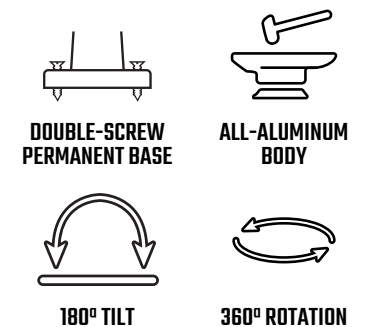

75MM VESA MAXX MAGNETIC

- 290LB PULL-FORCE MAGNET
- ALL-ALUMINUM BODY
- 180° TILT
- 360° ROTATION



- SKU: V75-MX-MAG
- 290lb pull-force magnet and all-aluminum housing allows for use around heavy-duty equipment
 - Two notches on either side of the housing offers 180 degrees of device tilt and 360 degree rotation
 - Expanded mounting options with included 2 Large Mounting Discs



75MM VESA SERIES

All Mob Armor 75mm VESA mounts are topped with a metal 75mm VESA pattern mounting plate, compatible with our Armor Series Tablet Enclosures, as well as other VESA pattern devices such as monitors and accessories.

75MM VESA MAXX DIRECT

- SKU: V75-MX-MK
- DOUBLE-SCREW PERMANENT BASE
 - ALL-ALUMINUM BODY
 - 180° TILT
 - 360° ROTATION



- Solid metal double-screw base allows for a secure universal mount to be fixed to any flat surface with included hardware.
- Two notches on either side of the housing offers 180 degrees of device tilt and 360 degree rotation

75MM VESA MAXX MOUNT

- SKU: V75-MX-VESA
- ALL-ALUMINUM BODY
 - 180° TILT
 - 360° ROTATION



- Double-sided 75mm VESA mount, with a plate on the device side and the mounting side.
- Two notches on either side of the housing offers 180 degrees of device tilt and 360 degree rotation



QUICK RELEASE DIRECT MAXX

SKU: GRIP-MX-MK



- DOUBLE-SCREW PERMANENT BASE
- ALL-ALUMINUM BODY
- 180° TILT
- 360° ROTATION

- Solid metal double-screw base allows for a secure universal mount to be fixed to any flat surface with included hardware.
- Equipped with a Mob Armor Quick-Release Mechanism and features an all-aluminum, easy-adjust ball housing capable of 180 degrees of tilt and 360 degree rotation.
- The Quick Release series is Mob Armor's solution to extreme tablet mounting. Only compatible with Mob Armor T-Series Tablet enclosures

- ADJUSTABLE DOUBLE CLAMP BASE
- ALL-ALUMINUM BODY
- 180° TILT
- 360° ROTATION

- Adjustable double clamp base locks the mount on to any tube or bar 1.5-2" in diameter
- Equipped with a Mob Armor Quick-Release Mechanism and features an all-aluminum, easy-adjust ball housing capable of 180 degrees of tilt and 360 degree rotation.
- The Quick Release series is Mob Armor's solution to extreme tablet mounting. Only compatible with Mob Armor T-Series Tablet enclosures

QUICK RELEASE TUBE MOUNT MAXX

SKU: GRIP-MX-TUBE



TABLET MOUNTING ACCESSORIES

Large Mounting Disc

SKU: TABN-MD



- Steel discs adhere with 3M VHB to any flat surface, allowing you to attach any of our magnetic mounts to non-ferrous surfaces.
- Package come with two mounting discs and alcohol surface cleaning wipes.
- Large Mounting Discs are designed specifically for use with our magnetic tablet mounts

TabNetic Plate

SKU: TABN-PL-ACC



- .02" thick steel plates adhere nearly flat to any device
- Package includes 2 TabNetic plates





ARMOR SERIES TABLET ENCLOSURES

Mob Armor enclosures are engineered with a two-panel design that surround your iPad to keep it safe in the most extreme environments. All hardware for installation is included.

Each enclosure is designed with a 75mm VESA pattern that works seamlessly with our VESA and Quick Release tablet mounts. Also compatible with our TabNetic and Tab Mount lines.

T2 POWDER-COATED FORMED SHEET METAL

- T2-102 - 10.2" iPads
- T2-105 - 10.5" iPads
- T2-110 - 11" iPads
- T2-110-PR02 - 11" iPad Pro, 2nd - 4th Gen

- Two part enclosure locks your iPad in, protecting it from dirt, debris, and other damage.
- Enclosure is CNC formed from Aluminum and Steel, powder coated for durability
- Assembled using high density closed cell EVA foam, and 18-8 Stainless Steel hardware
- Enclosure maintains access to 3.5mm audio jack, front camera, rear camera, home button, and charging/data port

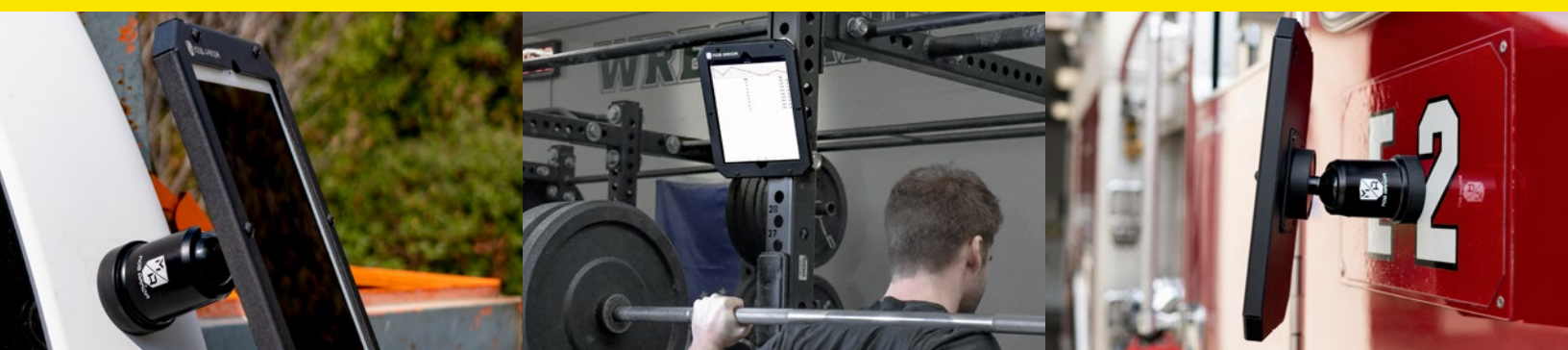

OTHER ACCESSORIES

Wire Harness

SKU: DUAL-USB-C-HARN

Designed a USB-C and USB-A port, this Quick Charge 3.0 Certified wire-harness is ready to install and charge multiple devices while you are on-road, off-road, or on the water. Built-in official Qualcomm smart chip will intelligently detect and simultaneously charge 2 devices at optimal current. Charge compatible devices up to 4 times faster than conventional charging.



FLASH GRIP

The original Mob Armor magnetic mount. The magnetic base allows for mounting to any ferrous surface, and is capable of rotating 360° and 70° of tilt for maximum articulation and expansion of mounting options. Comes in three sizes for any flashlight.



Flash Grip D

SKU: MOB-FLG-D
Holds most flashlights with D batteries



Flash Grip C

SKU: MOB-FLG-C
Holds most flashlights with C batteries



Flash Grip AA

SKU: MOB-FLG-AA
Holds most flashlights with AA batteries

Dual SkyPro GPS Case



SKU: GPS-E-D-SKY-V2

Protect your Dual SkyPro Receiver from the elements. Compatible with the Mob Armor GPS Mounting Kit. Race tested, and simple to set up.

GPS Mounting Kit

SKU: GPS-MOUNT-KIT-V2



Pair this pointing kit with the Dual SkyPro GPS Case for secure mounting on a roll cage or tubing. Will hold to any 1.5" to 2" tubing.

GPS Accessory Bundle

SKU: GPS-ACC-BNDL



Includes our GPS Case and Mounting Kit, as well as a SkyPro brand GPS Receiver (XGPS150) capable of fast-signal acquisition and 10Hz positioning updates - an ideal GPS for pilots, race car drivers, and other fast moving applications.



DIRT BAG

WITH FLOATING FLOOR

SKU: MOB-BAG-SM/MD/LG



- Two-compartment, heavy duty duffle bag made for everything from gym days to long vacations.
- Floating floor keeps two compartments completely separate, keeping your cleans and dirties separate.
- Top quality 1000C PVC dirt and water repellent fabric, top quality YKK zippers.
- Three sizes available - 23L Small, 40L Medium, and 68L Large.



TOP ZIPPER ACCESS

BOTTOM ZIPPER ACCESS

MOB ARMOR GPS

OFF ROAD GPS NAVIGATION



- Modern user interface and streamlined features convey information faster than any other GPS, letting you explore the world around you, and help you get back safely
- Track and monitor latitude, longitude, speed, elevation, and more
- Mark points of interest, save, edit and share your tracks and routes, plus download tracks of world renowned routes and events
- Free 30 day trial for all new users

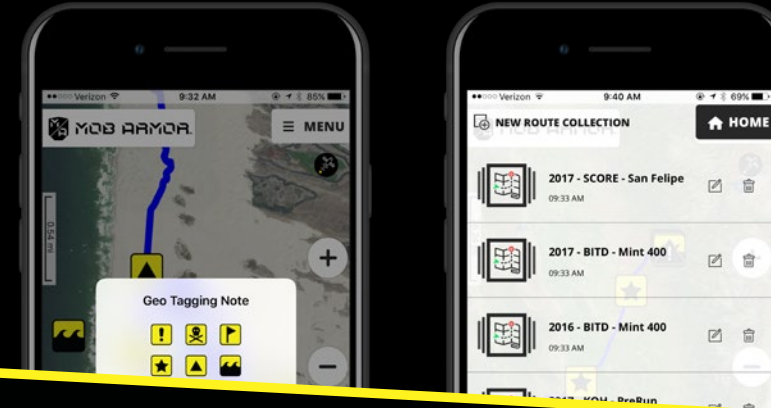

STAY ON TRACK WHILE OFF THE GRID



Tracking/Routes - Fast and Streamlined tracking will leave a trail of "breadcrumbs" that will allow you to move freely without concern of finding your way back to origin. Speed, distance, and elevation data is collected for each track. Turn Tracks into Routes and organise them in folders to keep all your favourite off-road locations and race files easy to access and share.

Performance Mode - Performance Mode is designed for racers to provide more information, and remove the possible problems associated with touchscreen in race environments.

Range Rings - These rings are accessed in the race mode menu and help users see distances as they approach turns and way-points.

Latitude & Longitude - Enter in coordinates in Decimal Degrees format to drop a pin to find exact points of interest.

GPS Configurations - Change between internal GPS receiver and the Dual Sky pro XGPS150 receiver via Bluetooth. Check GPS status and current Lat/Long coordinates to share.

Map Options - Choose between Satellite Image Maps, or standard maps to help with situational awareness.

Race Features now includes the ability to import GPX files and edit waypoint flag/icon. Add/edit texts and create geofence voice announcements.

Follow us on social media!



©2023 Mob Armor

Visit [MOBARMOR.COM](https://www.mobarmor.com) for product safety, Prop 65, and warranty information.

Mob Armor | 1235 W McCoy Lane, Ste E, Santa Maria, CA 93455